

EVA

Smart. Sleek. Solar.

Your Perfect City Car



One Of The Thousand Days With Eva

It's Monday morning and the city's alive.
You're running a bit **late**, but there's no rush.
In just 5 minutes, Eva is charged and ready to go.
You glide through the traffic on the streets **and find parking** where others can't. **The panoramic view opens up the city** in a way you've never noticed before.
No fumes, no fuss. **You reach** the office **on time**, relaxed and refreshed, **with the peace of mind that you're driving sustainably**. Eva makes every drive a moment to breathe.

Yes, Eva gets you to the point faster.



the spotlight that elevates your drive

Compact design

for nimble & agile city maneuvers

250 km range

on a single charge

Perfect fit

for 2 adults & 1 child

50 kms in 5 minutes

with super fast charging

Premium interiors

designed for comfort & style

0-40 kmph

in 5 seconds



turn sunshine into motion!

Eva makes solar-powered rides a reality-
Accessible, sustainable, and oh-so-smart,
it's the solar revolution you've been waiting for.



Free

Up to 3,000 km of sun-powered
driving annually



Charging

Clean energy, whether parked
or driving



Efficient

High-performance solar panels for
maximum energy capture



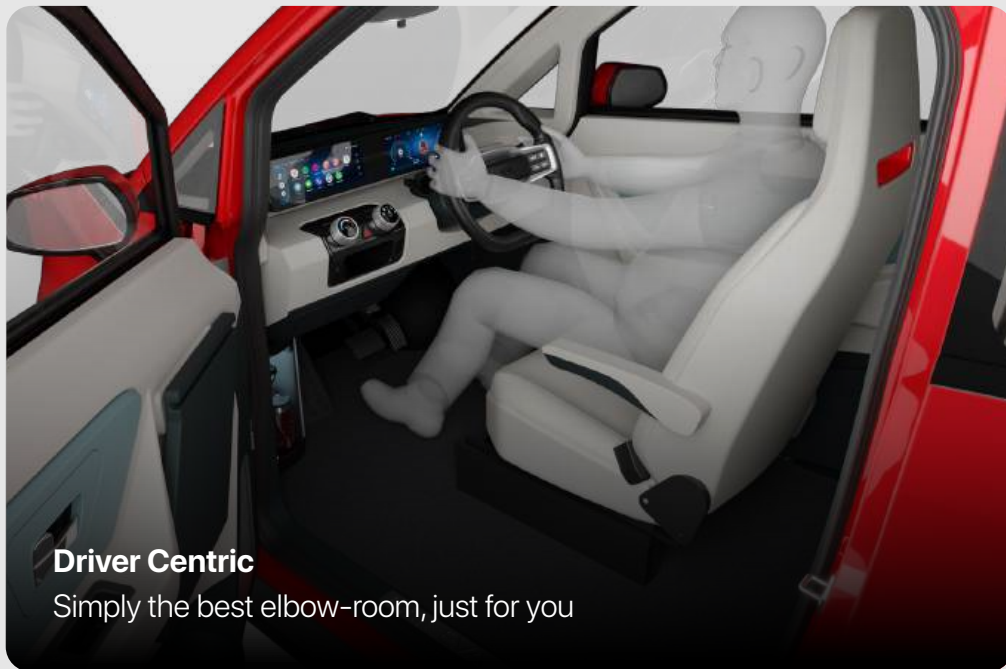

Driver Centric

Simply the best elbow-room, just for you

premium experience

Your personal urban oasis.
Step into Eva and discover a space
designed around you!



Expansive View

Wide driver visibility ensures effortless road awareness
and easy driving judgement on busy city streets

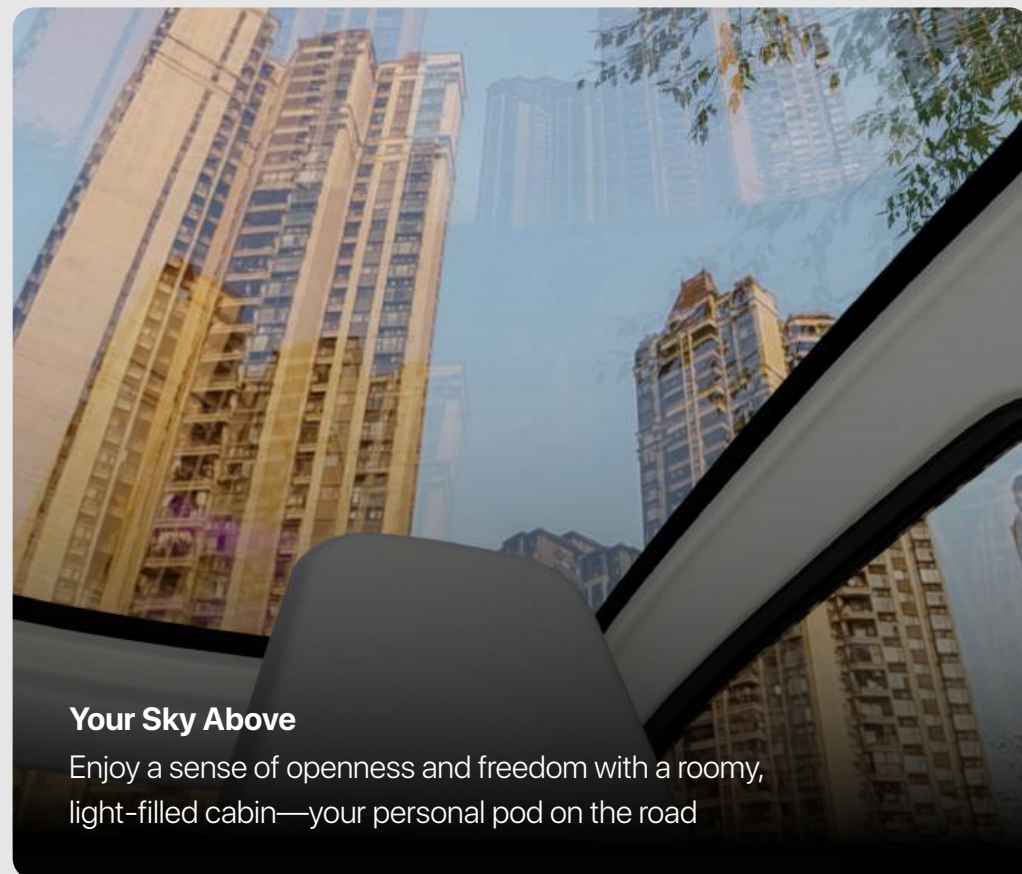

Your Sky Above

Enjoy a sense of openness and freedom with a roomy,
light-filled cabin—your personal pod on the road



Electronic Parking Brake

Experience effortless control with a modern electronic parking brake for a hassle-free stop at your destinations



USB Type C Charger

Charge your laptop on the go with convenient 45W power, ensuring powered up devices for the entire day



Armrest

Takes off pressure from those congested city drives



Superior Ingress & Egress

Easy access in and out, designed for ultimate comfort and convenience every time you ride



follow-me-home headlamp

Guiding you safely- headlamps that light your way after you've parked

IRVM dimming

Drive comfortably with auto-dimming mirrors that reduce glare for safer night journeys

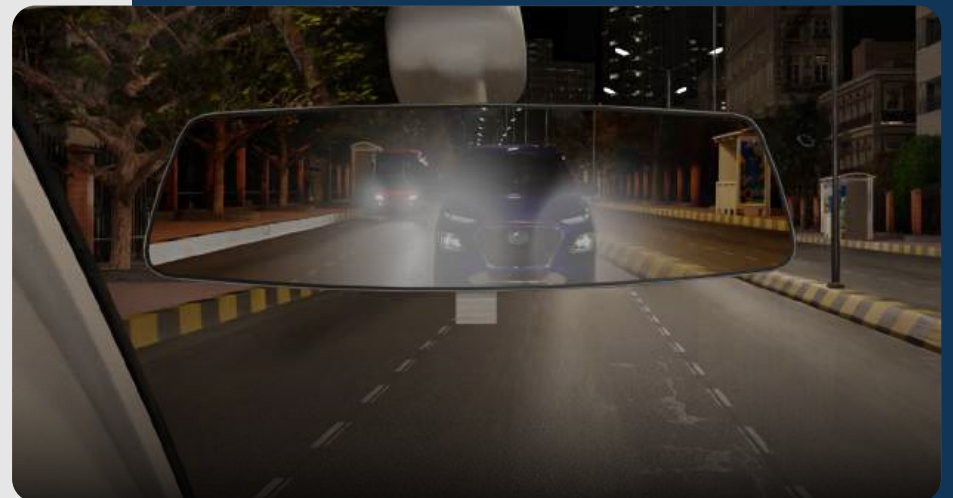

smart connectivity

Stay in control - monitor and manage car features seamlessly with the dedicated app



PM2.5

Breathe pure, drive fresh—Eva's PM2.5 air purifier ensures a pollutant-free cabin environment for your comfort and health

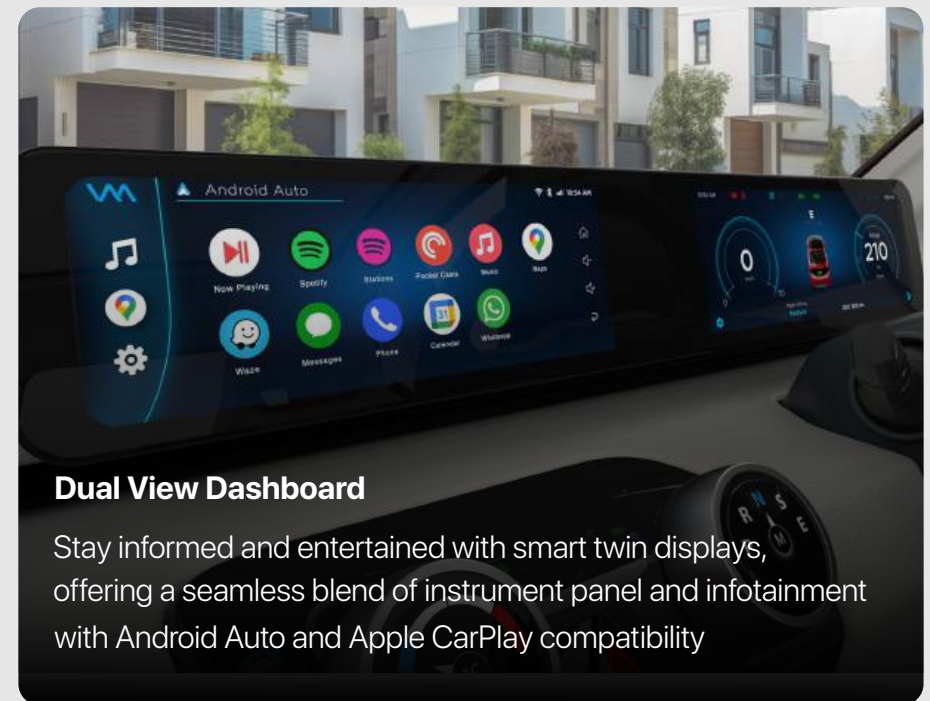

Dual View Dashboard

Stay informed and entertained with smart twin displays, offering a seamless blend of instrument panel and infotainment with Android Auto and Apple CarPlay compatibility

Foldable food tray

Versatility for a quick road-side snack, transforming car door into a handy dining space

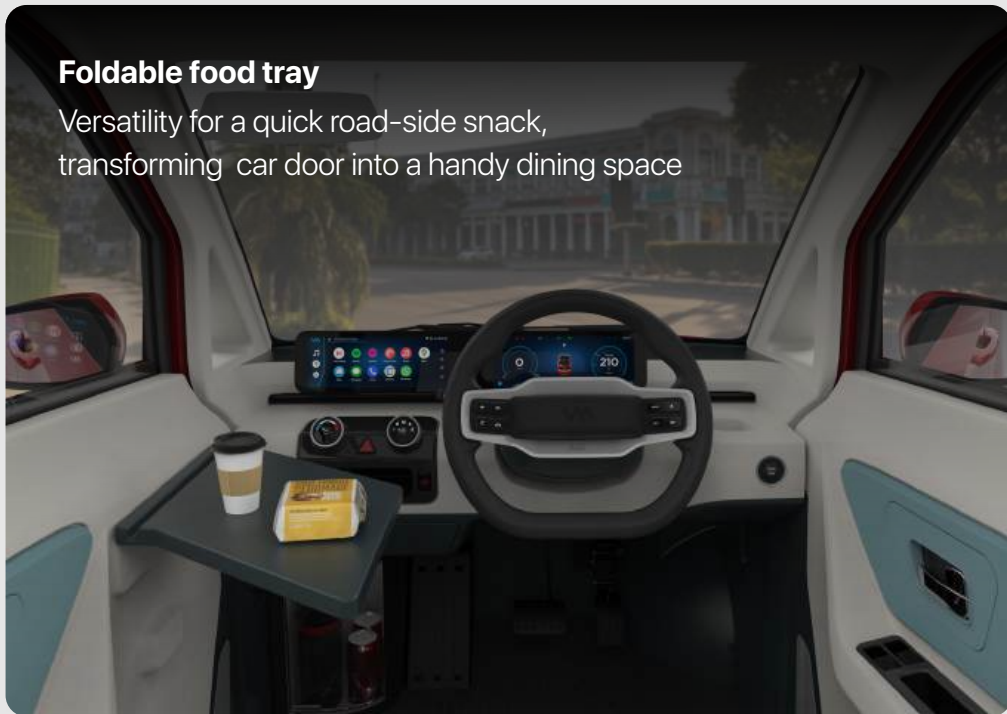

Storage Unleashed

With 300L of flexible storage, Eva fits everything from grocery hauls to a cricket kit, making solo city trips a breeze

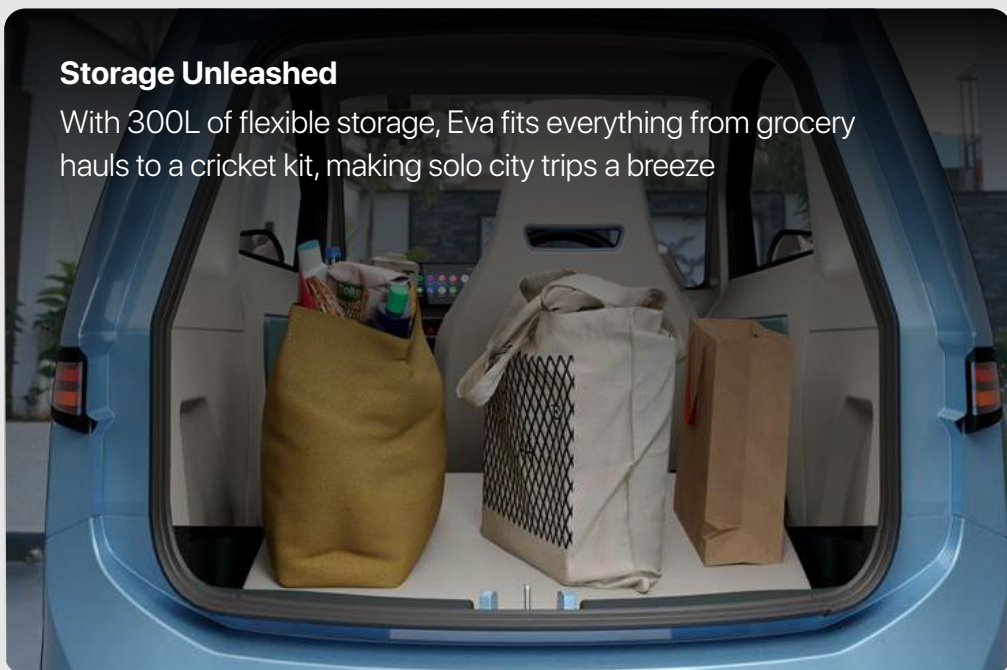

Cool Convenience

Refresh on the go! Keep your drinks perfectly chilled with the integrated cool box



battery you can trust



Convenient Home Charging

Full charge in just 5 hours using a standard 15A household socket



rapid boost

10% to 70% charge in 15 minutes with CCS2 DC charging

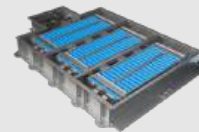

LFP Chemistry

Liquid Cooled 18 kWh battery designed for diverse climate conditions



Lasting Confidence

Extended warranty for 8 years*

Configurable Charging Limit

Take control of your charging with customised charging

monocoque chassis

Robust steel panel body structure with aluminium components for enhanced strength and stability



Driver Airbag

Enhanced protection when used with seat belt, over and above regulatory requirements

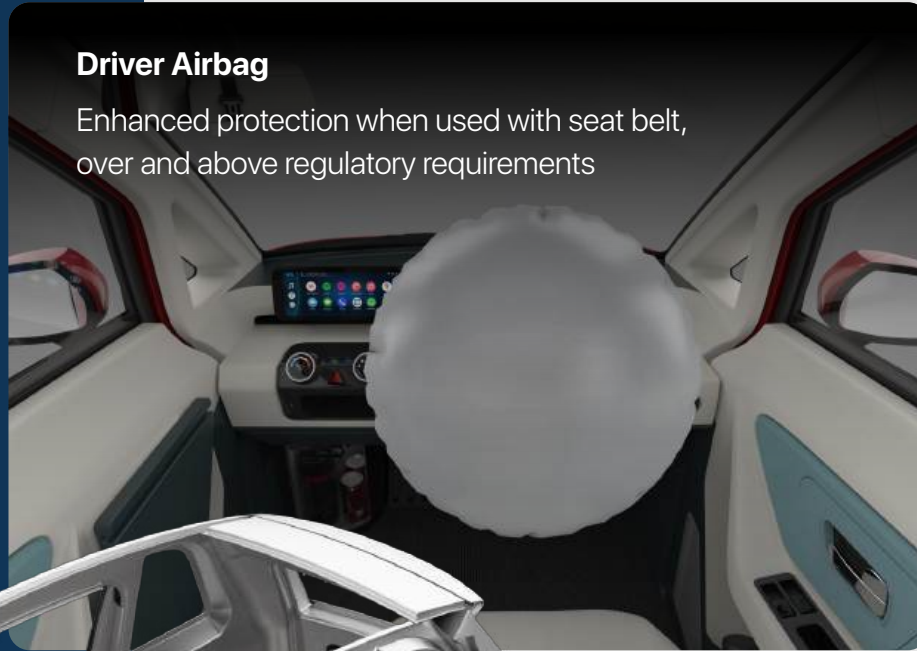

IP67 Rated Powertrain

Worry free water resistance, including wading through monsoon floods



safety at its core

Eva is built with your safety in mind for active, passive, and electrical protection all in one.

Crash Certification

Front crumple zone engineered to absorb impact forces

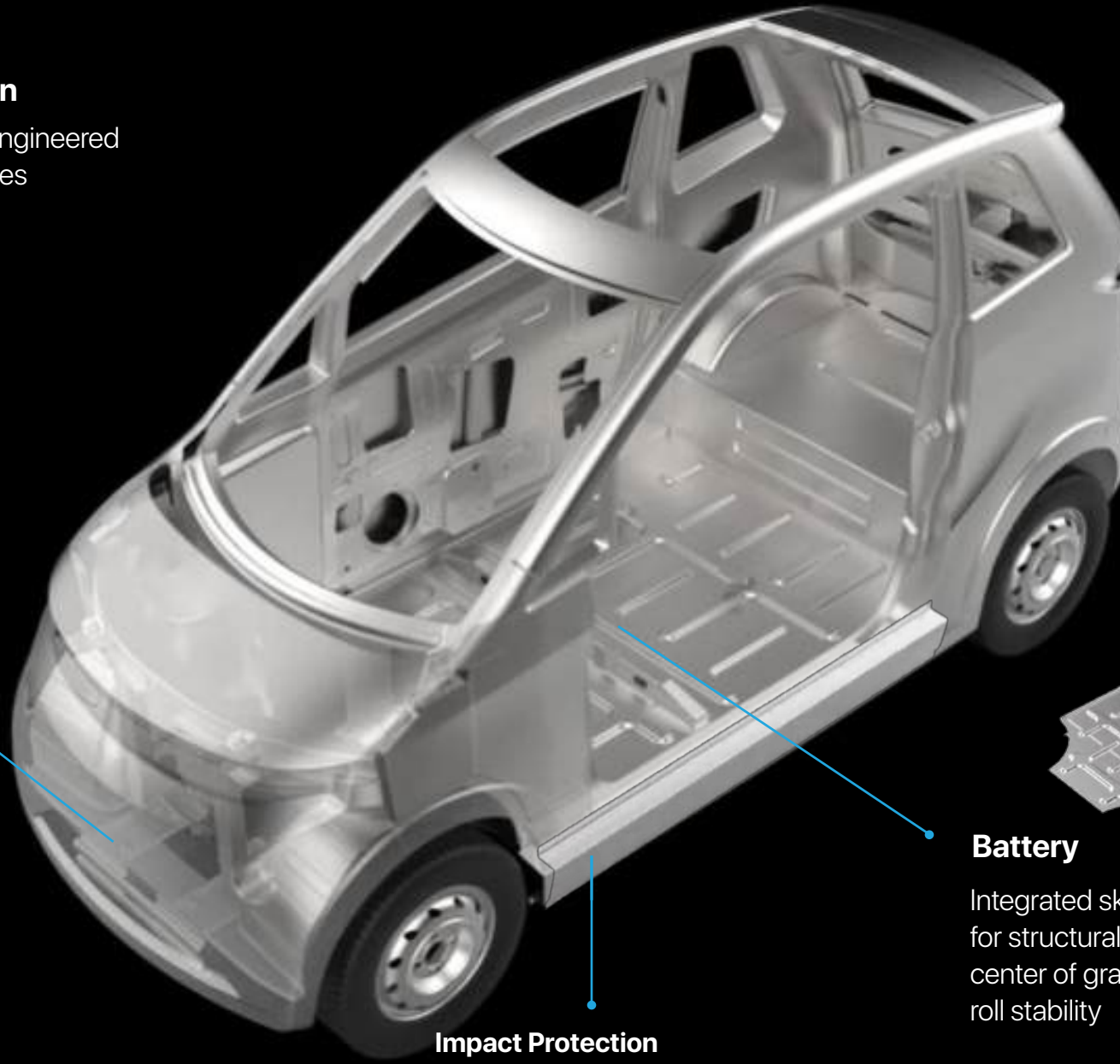
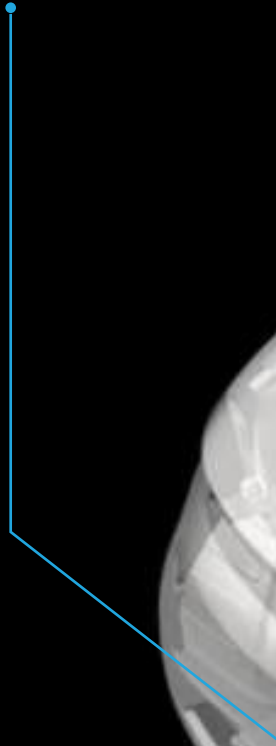

Impact Protection

Side sill structure supports the chassis and enhances occupant and battery safety

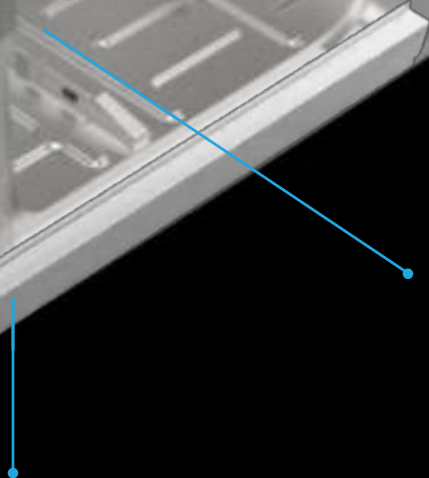

Battery

Integrated skateboard battery for structural strength with low center of gravity for enhanced roll stability

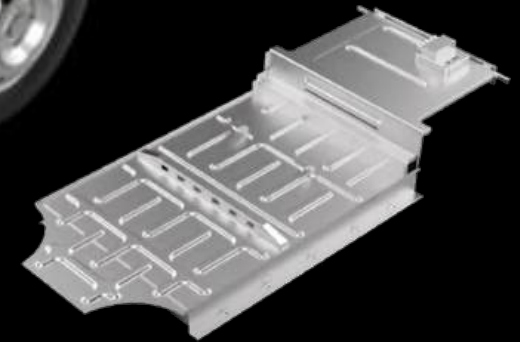

hill hold assist

Conquer steep inclines with confidence, Hill Hold Assist prevents rollback for a safe & smooth start

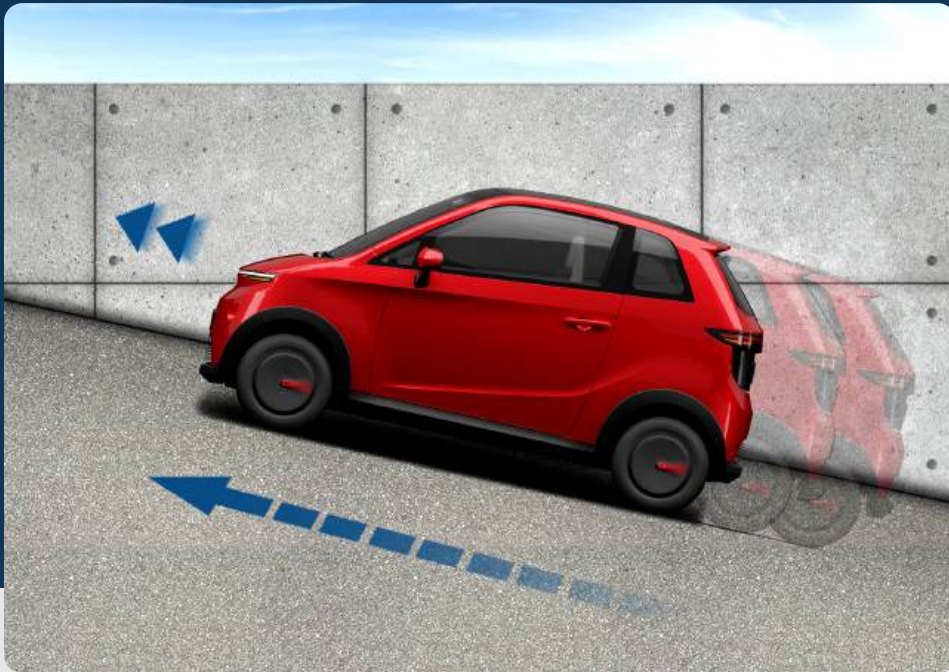

Front Disc Brakes

Superior stopping power with front disc brakes for enhanced safety and control in driving



TPMS

Stay safe with real-time alerts on tyre pressure, avoiding unexpected flats and ensuring optimal driving performance

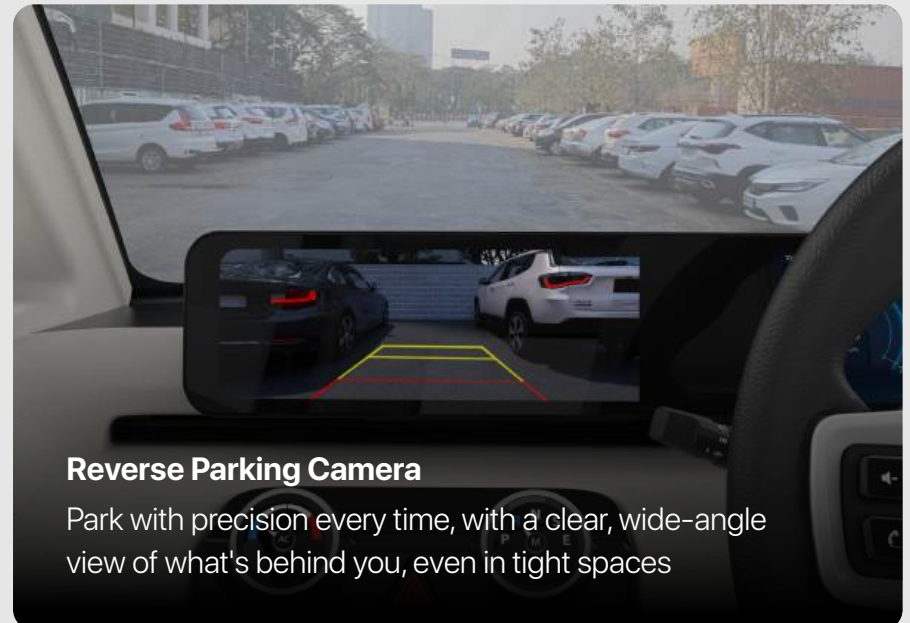

Reverse Parking Camera

Park with precision every time, with a clear, wide-angle view of what's behind you, even in tight spaces

performance

Feel the thrill of superior torque and acceleration, with regenerative braking tailored to your driving style.



5 Sec

0-40 kmph



3 User Settings

Regenerative Braking



tech that's a step ahead

Advanced connected features tailored for your daily journeys

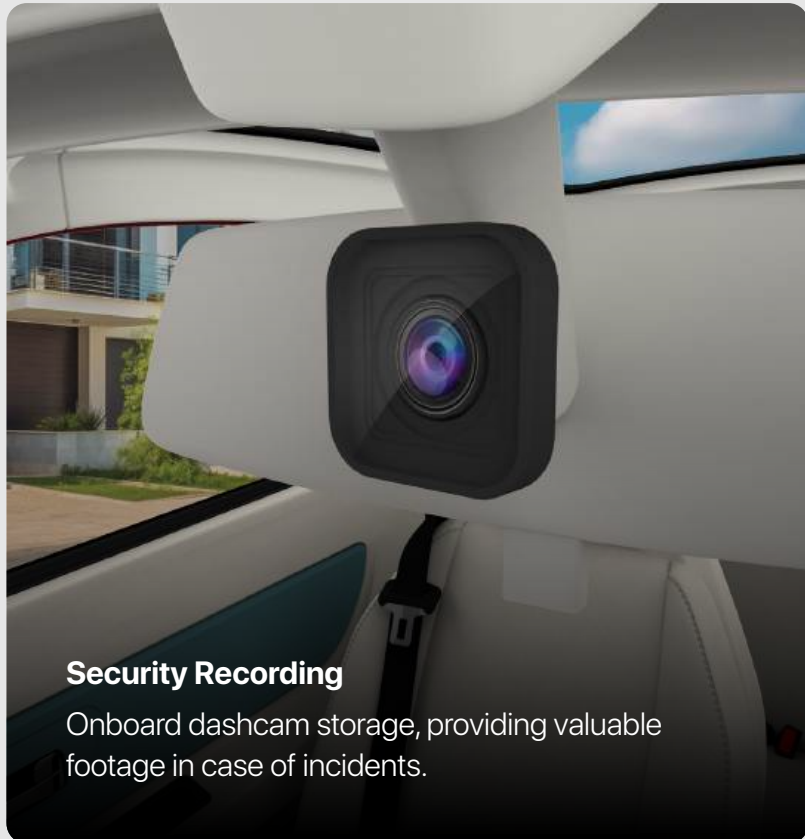

Security Recording

Onboard dashcam storage, providing valuable footage in case of incidents.

Usage Analysis
Unlock smarter driving by tracking driving patterns, monitoring performance metrics to enhance efficiency, longevity and safety.

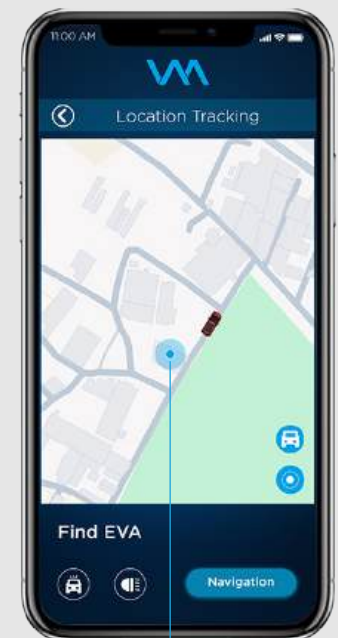

Location Tracking & Remote Diagnostics

Easily keep track of your car's location & Monitor your car's health from anywhere for peace of mind, always

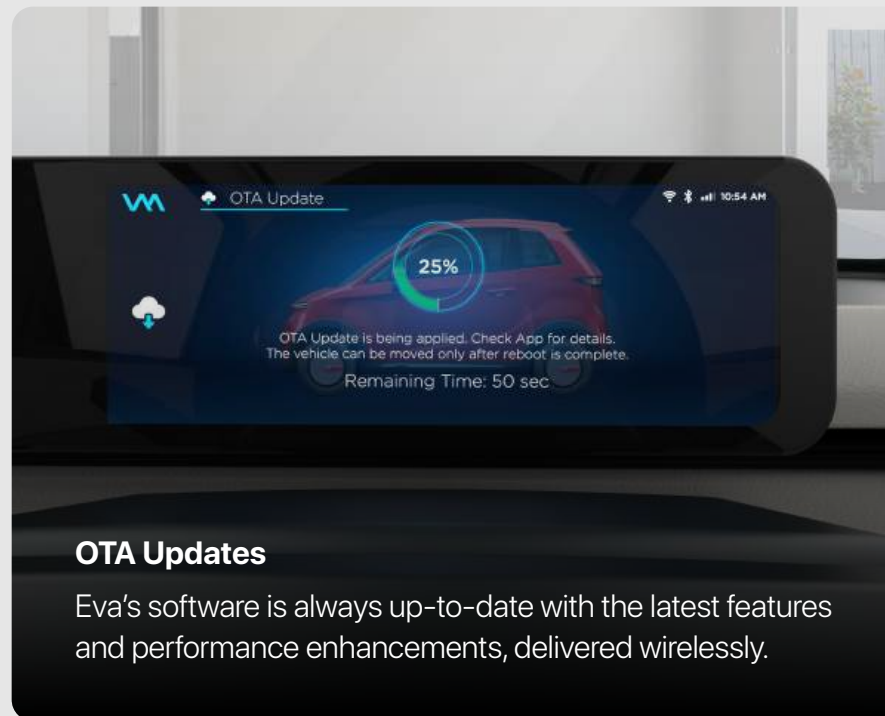

OTA Updates

Eva's software is always up-to-date with the latest features and performance enhancements, delivered wirelessly.

the smart choice for daily savings

Eva's efficiency slashes your fuel costs
to 1/10th of a petrol hatchback!



savings breakdown

If you drive 30 kms
everyday, you'd save

₹53,576 annually

₹3,75,032 in 7 years

Average 6 months petrol price considered: Rs.106/L. Average Home Charging cost assumed at Rs. 10/KWh.
Real world mileage for Petrol Hatchback taken as 18km/L. Actual savings may vary depending upon location, cost of power and driving behaviour.

battery subscription model

Buy the vehicle, lease battery on a monthly plan

Accessible

Even lower upfront cost

Flexible

Pay-as-you-go

Hassle-free

No battery life worries



drive clean, drive green



Compact Design

Eva needs significantly less materials compared to traditional cars

Efficient Battery

Lithium-Ferro-Phosphate chemistry is among the lowest mine-to-battery emissions per kWh

Low-Impact Manufacturing

Advanced materials & processes help reduce Eva's manufacturing emissions

Emission-Free Charging

Eva's solar roof helps drivers reduce up to 3,000 km worth of electricity emissions

Zero Tailpipe Emissions

Eva produces no emissions while driving, unlike internal combustion engine cars

pre-book EVA today

Be among the first 25,000 and unlock exclusive perks!



8-Year Battery Warranty

Drive worry-free for nearly a decade



Unlimited OTA Updates

Your Eva gets smarter with every update



3 Years Complimentary Data Subscription

Stay connected, no extra costs

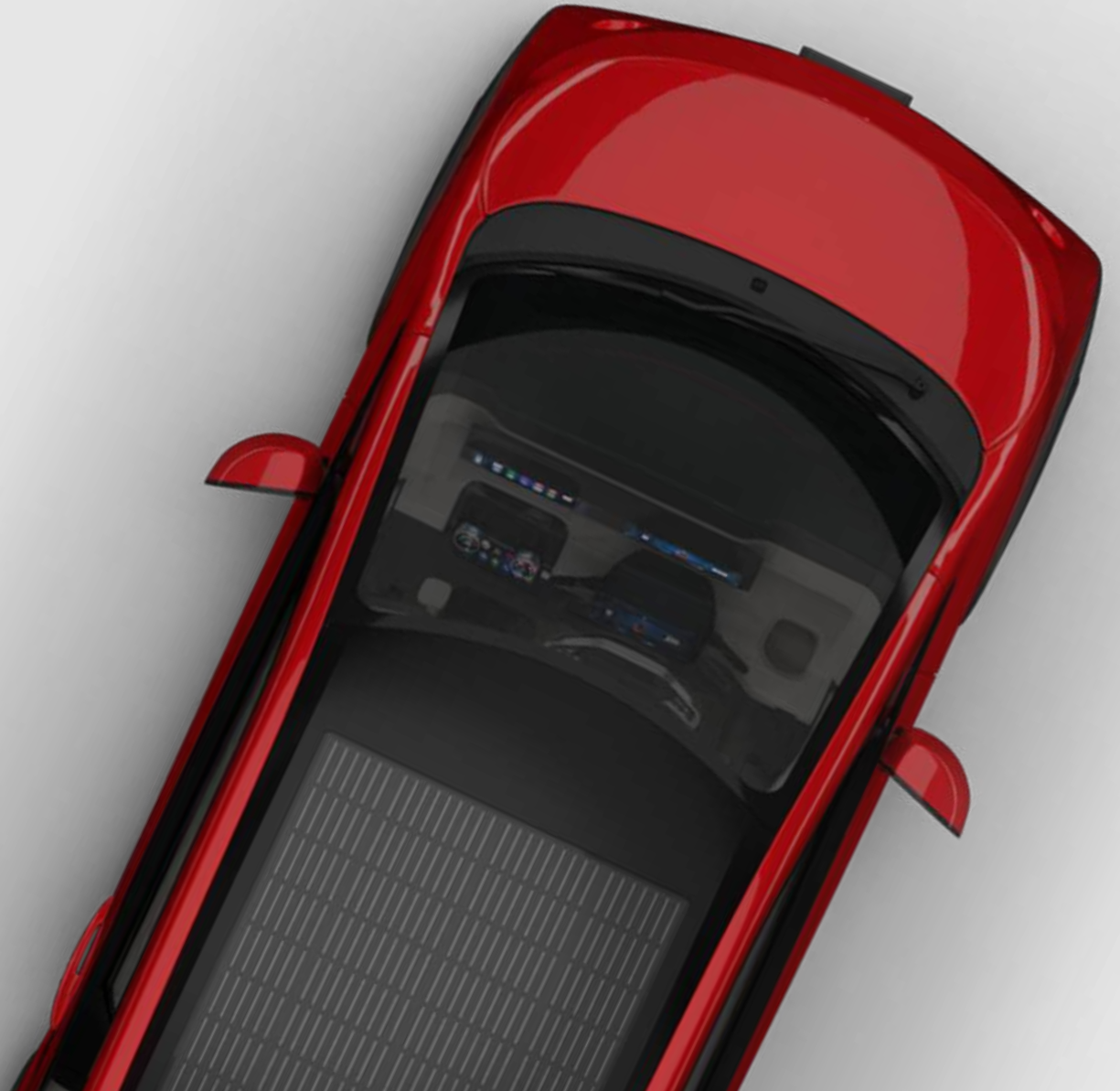

share the joy, earn the rewards

Join Eva's referral program



Spread the Word

Invite friends and family to join the Eva revolution.



Earn 5,000 Reward Points

For every successful referral



Redeem and Enjoy

Use your points within the VM ecosystem for exclusive discounts and offers

Why Wait? Pre-book now and power up the future!



Key Vehicle Specifications	All Variants		
Seating Capacity	2 Adults + 1 Child		
Doors	3		
Solar Integration Option	✓		
Air Conditioning	✓		
Power Windows	✓		
Follow-me-home Lights	✓		
Front Suspension	Independent MacPherson Strut with Coil Spring		
Rear Suspension	Dual Shock Suspension		
Adjustable Steering	Tilt		
Steering Gear Type	Rack and Pinion		
Turning Radius (m)	3.9		
Lithium Battery Chemistry	Lithium Ferro Phosphate		
Water Resistance Rating	IP67		
Transmission Type	Single Speed Automatic		
Powertrain	Battery Electric		
Drive Train	Rear Wheels		
Motor Type	PMSM		
0-40 kmph (second)	5		
Max Payload (kg)	250		
Gradeability (%)	25%		
Battery	Nova	Stella	Vega
Capacity (kWhr)	9	12.6	18
Voltage (V)	48	48	320
Thermal Management	Air Cooled	Air Cooled	Liquid Cooled
Regenerative Braking	Fixed On/Off	Yes, Configurable	Yes, Configurable
Extended Warranty	-	✓	✓
Charging Time			
AC Home Charging, 10-90% (hour)	5	5	5
DC Fast Charging, 10-70% (minute)	-	-	20
Comfort & Convenience			
Climate Control	-	✓	✓
Smart Connectivity	-	✓	✓
Interior	Basic	Standard	Premium
Panoramic Glass Roof	-	✓	✓
Steering Mounted Audio, Phone and Voice Controls	-	-	✓
Apple CarPlay™ & Android Auto™	-	✓	✓
Connectivity App	-	✓	✓
USB	22.5 W	22.5 W	45 W pd
Chill Box	-	-	✓
Speakers	-	2	4
Ignition / Start-stop	Key	Button	Button
Driver Seat Height Adjustment	-	-	✓

Power Transmission	Nova	Stella	Vega
Peak Power (kW)	12	12	15
Mode	Eco	Eco-City	Eco-City-Sport
Suspension Brakes Steering			
Brakes	Front & Rear Drum	Front & Rear Drum	Front Disc & Rear Drum
Tyre Size	155/80 R12	155/65 R13	155/65 R13
Wheels	Steel	Steel + Wheel Caps	Steel + Wheel Caps
Performance			
Top Speed (kmph)	60	60	70
Driving Range (km)	125	175	250
Safety			
Headlights	Halogen	LED	LED
Anti-pinch Window	-	-	✓
Reversing Camera	-	✓	✓
Parking Sensor	-	✓	✓
Airbag	-	-	✓
TPMS	-	-	✓
Central Locking	-	✓	✓
Speed Sensing Door Lock	-	✓	✓
IRVM Dimming	Manual	Auto	Auto

Dimensions



Different Shades



EVA

Let Eva redefine your drive.
Smart. Sleek. Solar.

